

REVISONS		DATE	BY	APPV
S4	REVISED PER ECO-11-004587	11MAR11	RK	HMR

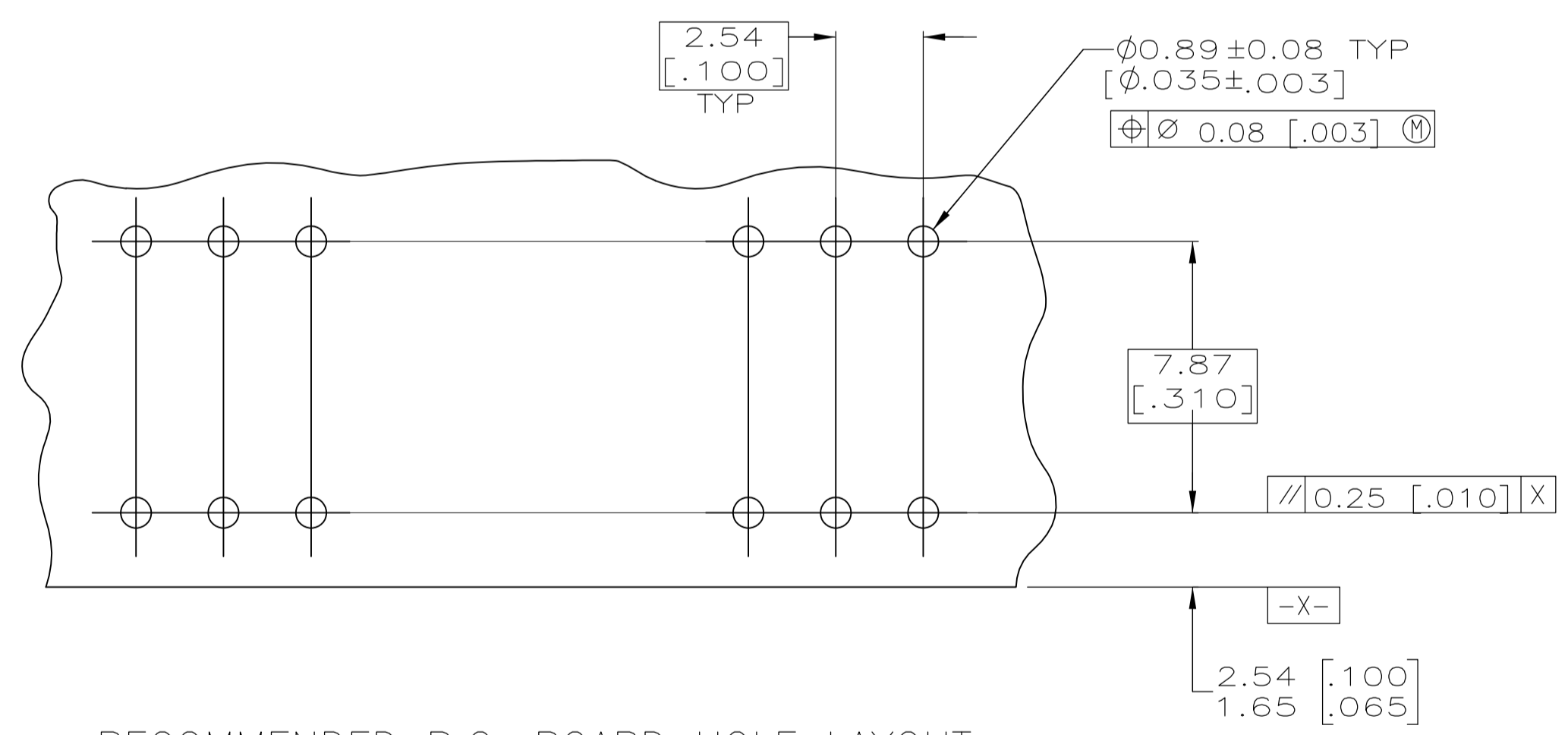
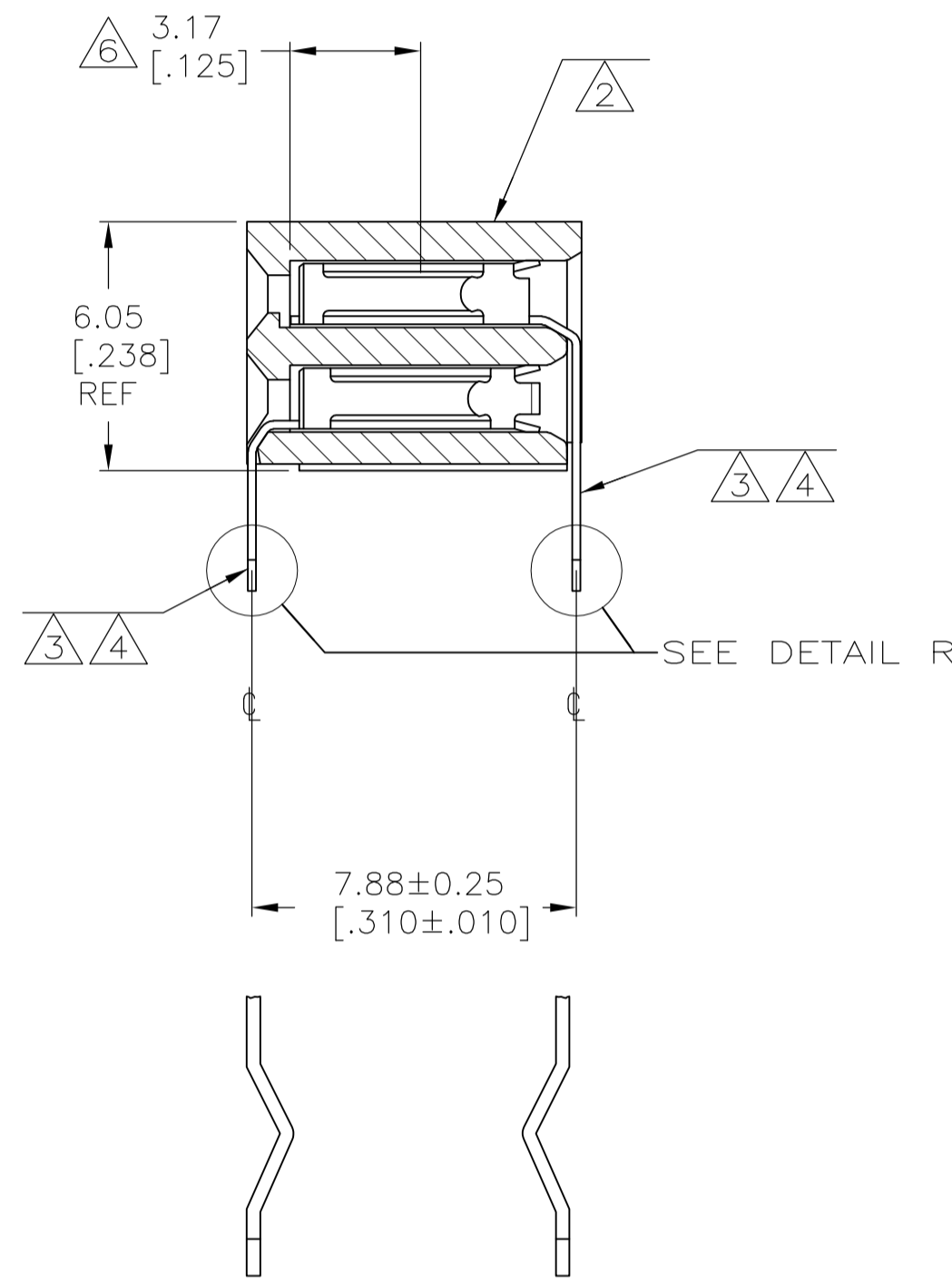
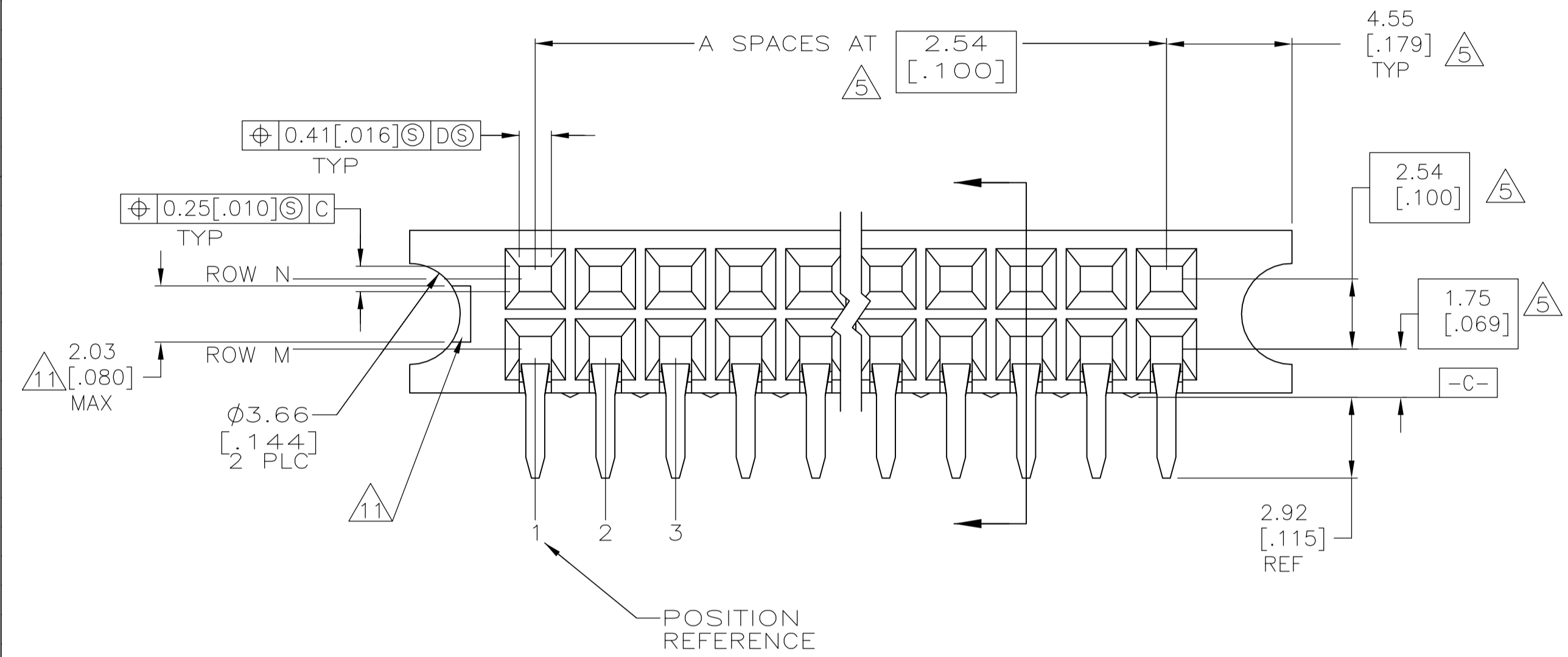
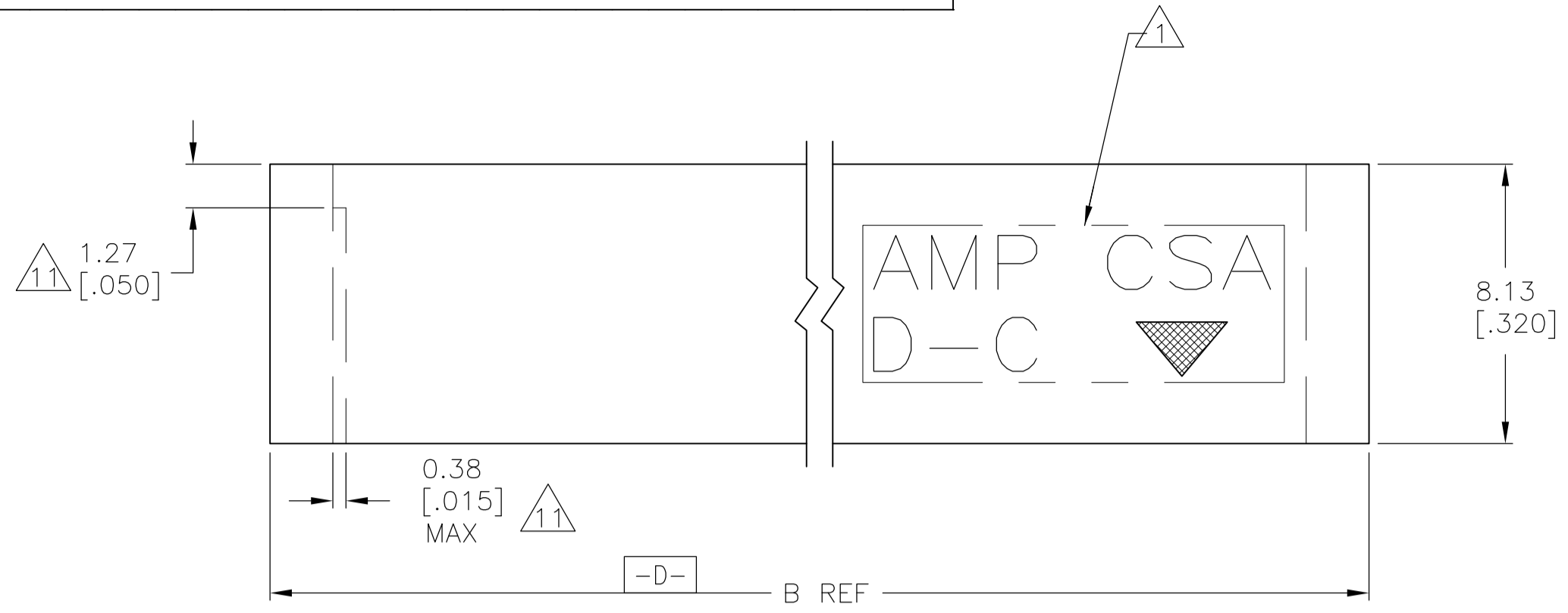

RECOMMENDED P.C. BOARD HOLE LAYOUT

DETAIL R  
BOARD RETENTION FEATURE  
SCALE 10:1

- 1 "AMP", "CSA", "▼" AND "DATE CODE" WITH .062 ± 0.015 HIGH CHARACTERS WHERE SIZE PERMITS.
- 2 HOUSING: 1-70 POSITION SIZES MAY BE PPS, GLASS-FILLED OR PCT, GLASS-FILLED, POSITION SIZES GREATER THAN 70 WILL BE PPS, GLASS-FILLED.
- 3 CONTACT: PHOSPHOR BRONZE.
- 4 CONTACT FINISH: DUPLEX PLATED 0.00076 [0.00030] GOLD IN CONTACT AREA, 0.00127-0.00254 [0.00050-0.00100] BRIGHT TIN-LEAD ON SOLDER TAILS, ALL OVER 0.00127 [0.00050] NICKEL.
- 5 THESE DIMENSIONS PERTAIN TO CAVITY C'S ONLY, NOT TO CONTACT LOCATIONS.
- 6 POINT OF MEASUREMENT FOR PLATING THICKNESS (INSIDE CONTACT BEAMS).
- 7. CSA LOGO INK STAMPED WHITE ON HOUSING.

- 8 PRELIMINARY PART - NOT RELEASED FOR PRODUCTION
- 9 CONTACT FINISH: DUPLEX PLATED 0.00076 [0.00030] GOLD IN CONTACT AREA, 0.00127-0.00254 [0.00050-0.00100] MATTE TIN ON SOLDER TAILS, ALL OVER 0.00127 [0.00050] NICKEL.
- 10 ROHS 2002/95/EC COMPLIANT.
- 11 RECESSED AREA AROUND MOLD GATE IS OPTIONAL. THIS FEATURE IS ALLOWABLE ON EITHER SIDE OF HOUSING OR MAY NOT BE PRESENT AT ALL.
- 12 OBSOLETE PARTS: OBSOLETE CIS STREAMLINING PER D.RENAUD/D.SINISI

FINISH	ROW M	ROW N	B	A	NO OF POSN	PART NUMBER
12	1, 4	1, 4	16.71 [0.658]	3	8	7-534204-2
12	1, 3	1, 3	14.17 [0.558]	2	6	7-534204-1
12	1, 2, 50, 51, 99, 100	1, 2, 50, 51, 99, 100	260.55 [10.258]	99	200	7-534204-0
12	1, 2, 40, 41, 79, 80	1, 2, 40, 41, 79, 80	209.75 [8.258]	79	160	6-534204-9
12	1, 2, 35, 36, 69, 70	1, 2, 35, 36, 69, 70	184.35 [7.258]	69	140	6-534204-8
12	1, 2, 32, 33, 64, 65	1, 2, 32, 33, 64, 65	171.65 [6.758]	64	130	6-534204-7
12	1, 2, 27, 28, 54, 55	1, 2, 27, 28, 54, 55	146.25 [5.758]	54	110	6-534204-6
12	1, 2, 47, 48	1, 2, 47, 48	128.47 [5.058]	47	96	6-534204-5
12	1, 2, 35, 36	1, 2, 35, 36	97.99 [3.858]	35	72	6-534204-4
12	1, 2, 34, 35	1, 2, 34, 35	95.45 [3.758]	34	70	6-534204-3
12	1, 2, 19, 20	1, 2, 19, 20	57.35 [2.258]	19	40	6-534204-2
12	1, 2, 11, 12	1, 2, 11, 12	37.03 [1.458]	11	24	6-534204-1
12	1, 2, 7, 8	1, 2, 7, 8	26.87 [1.058]	7	16	6-534204-0
12	1, 2, 9, 10	1, 2, 9, 10	31.95 [1.258]	9	20	5-534204-9
12	1, 2, 39, 40	1, 2, 39, 40	108.15 [4.258]	39	80	5-534204-8
12	1, 2, 30, 31, 59, 60	1, 2, 30, 31, 59, 60	158.95 [6.258]	59	120	5-534204-7
12	1, 2, 25, 26, 49, 50	1, 2, 25, 26, 49, 50	133.55 [5.258]	49	100	5-534204-6
12	1, 2, 29, 30	1, 2, 29, 30	82.75 [3.258]	29	60	5-534204-5
12	1, 2, 14, 15	1, 2, 14, 15	44.65 [1.758]	14	30	5-534204-4
12	1, 2, 17, 18	1, 2, 17, 18	52.27 [2.058]	17	36	5-534204-3
12	1, 2, 5, 6	1, 2, 5, 6	21.79 [0.858]	5	12	5-534204-2
12	1, 2, 24, 25	1, 2, 24, 25	70.05 [2.758]	24	50	5-534204-1
12	1, 4	1, 4	16.71 [0.658]	3	8	2-534204-2
12	1, 3	1, 3	14.17 [0.558]	2	6	2-534204-1
12	1, 2, 50, 51, 99, 100	1, 2, 50, 51, 99, 100	260.55 [10.258]	99	200	2-534204-0
12	1, 2, 40, 41, 79, 80	1, 2, 40, 41, 79, 80	209.75 [8.258]	79	160	1-534204-9
12	1, 2, 35, 36, 69, 70	1, 2, 35, 36, 69, 70	184.35 [7.258]	69	140	1-534204-8
12	1, 2, 32, 33, 64, 65	1, 2, 32, 33, 64, 65	171.65 [6.758]	64	130	1-534204-7
12	1, 2, 27, 28, 54, 55	1, 2, 27, 28, 54, 55	146.25 [5.758]	54	110	1-534204-6
12	1, 2, 47, 48	1, 2, 47, 48	128.47 [5.058]	47	96	1-534204-5
12	1, 2, 35, 36	1, 2, 35, 36	97.99 [3.858]	35	72	1-534204-4
12	1, 2, 34, 35	1, 2, 34, 35	95.45 [3.758]	34	70	1-534204-3
12	1, 2, 19, 20	1, 2, 19, 20	57.35 [2.258]	19	40	1-534204-2
12	1, 2, 11, 12	1, 2, 11, 12	37.03 [1.458]	11	24	1-534204-1
12	1, 2, 7, 8	1, 2, 7, 8	26.87 [1.058]	7	16	1-534204-0
12	1, 2, 9, 10	1, 2, 9, 10	31.95 [1.258]	9	20	534204-9
12	1, 2, 39, 40	1, 2, 39, 40	108.15 [4.258]	39	80	534204-8
12	1, 2, 30, 31, 59, 60	1, 2, 30, 31, 59, 60	158.95 [6.258]	59	120	534204-7
12	1, 2, 25, 26, 49, 50	1, 2, 25, 26, 49, 50	133.55 [5.258]	49	100	534204-6
12	1, 2, 29, 30	1, 2, 29, 30	82.75 [3.258]	29	60	534204-5
12	1, 2, 14, 15	1, 2, 14, 15	44.65 [1.758]	14	30	534204-4
12	1, 2, 17, 18	1, 2, 17, 18	52.27 [2.058]	17	36	534204-3
12	1, 2, 5, 6	1, 2, 5, 6	21.79 [0.858]	5	12	534204-2
12	1, 2, 24, 25	1, 2, 24, 25	70.05 [2.758]	24	50	534204-1

THIS DRAWING IS A CONTROLLED DOCUMENT. DIMENSIONS: mm [INCHES]. TOLERANCES UNLESS OTHERWISE SPECIFIED: 0 PLC ±, 1 PLC ±, 2 PLC ±, 3 PLC ±, 4 PLC ±. MATERIAL: 2/3. FINISH: SEE TABLE. WEIGHT: -. SIZE: A1. DRAWING NO: 00779. CUSTOMER DRAWING. SCALE: 6:1. SHEET: 1 OF 1. REV: S4.

STE TE Connectivity  
RECEPTACLE ASSY, MOD II, DBL ROW, 2.54 X 2.54 [1.00 X .100] CL, GUIDE PIN EARS, CLOSED ENTRY.